

CUSTOMER PRINT

PART NUMBER: 3282-XSG-5XXW(CCX)

- NOTES:**
 1. ALL PART TO BE BULK PACKED
 2. CONTACTS ARE ASSEMBLED INTO CONNECTOR AS SHOWN
 3. ALL DIMENSION ARE REFERENCE EXCEPT THOSE WITH A TOLERANCE

ASS'Y P/N	COUPLING RING COLOR
3282-XSG-5XXWCC1	WHITE
3282-XSG-5XXWCC2	RED
3282-XSG-5XXWCC3	BLUE
3282-XSG-5XXWCC4	LIGHT GREY
3282-XSG-5XXWCC5	YELLOW
3282-XSG-5XXWCC6	MAROON
3282-XSG-5XXWCC7	GREEN

CONN. KIT P/N	NO. OF CONTACTS
3282-4SG-5XXW	4-#20
3282-5SG-5XXW	5-#20
3282-6SG-5XXW	6-#20
3282-7SG-5XXW	7-#20
3282-8SG-5XXW	8-#20
3282-9SG-5XXW	9-#20

CONN. KIT P/N	GROMMET FOR CABLE	"X" DIM.
3282-XSG-515W	.156 I.D. FOR CABLE .15-.17 O.D. [3.8-4.3mm]	Ø0.77 [19.6mm]
3282-XSG-518W	.187 I.D. FOR CABLE .18-.20 O.D. [4.6-5.1mm]	Ø0.77 [19.6mm]
3282-XSG-521W	.225 I.D. FOR CABLE .21-.23 O.D. [5.3-5.8mm]	Ø0.77 [19.6mm]
3282-XSG-524W	.250 I.D. FOR CABLE .24-.27 O.D. [6.1-6.8mm]	Ø0.77 [19.6mm]
3282-XSG-528W	.285 I.D. FOR CABLE .28-.29 O.D. [7.1-7.4mm]	Ø0.77 [19.6mm]
3282-XSG-530W	.312 I.D. FOR CABLE .30-.32 O.D. [7.6-8.1mm]	Ø0.77 [19.6mm]
3282-XSG-535W	.375 I.D. FOR CABLE .35-.40 O.D. [8.9-10.2mm]	Ø0.83 [21.1mm]

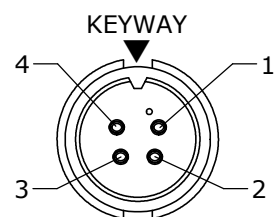

FACE VIEW

P/N: 3282-4SG-5XXW

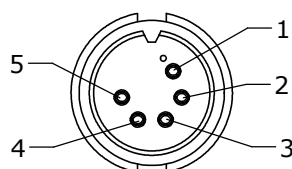

FACE VIEW

P/N: 3282-5SG-5XXW

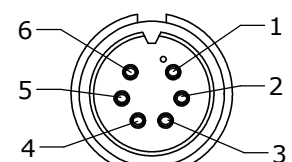

FACE VIEW

P/N: 3282-6SG-5XXW

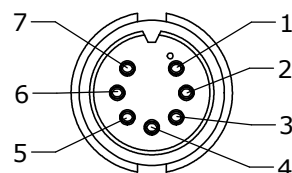

FACE VIEW

P/N: 3282-7SG-5XXW

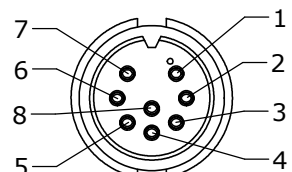

FACE VIEW

P/N: 3282-8SG-5XXW

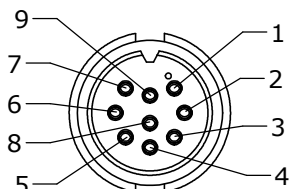

FACE VIEW

P/N: 3282-9SG-5XXW

GROMMET SIZE SEE LIST

NO OF CONTACTS

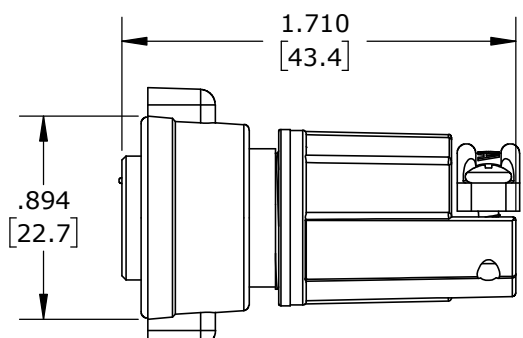
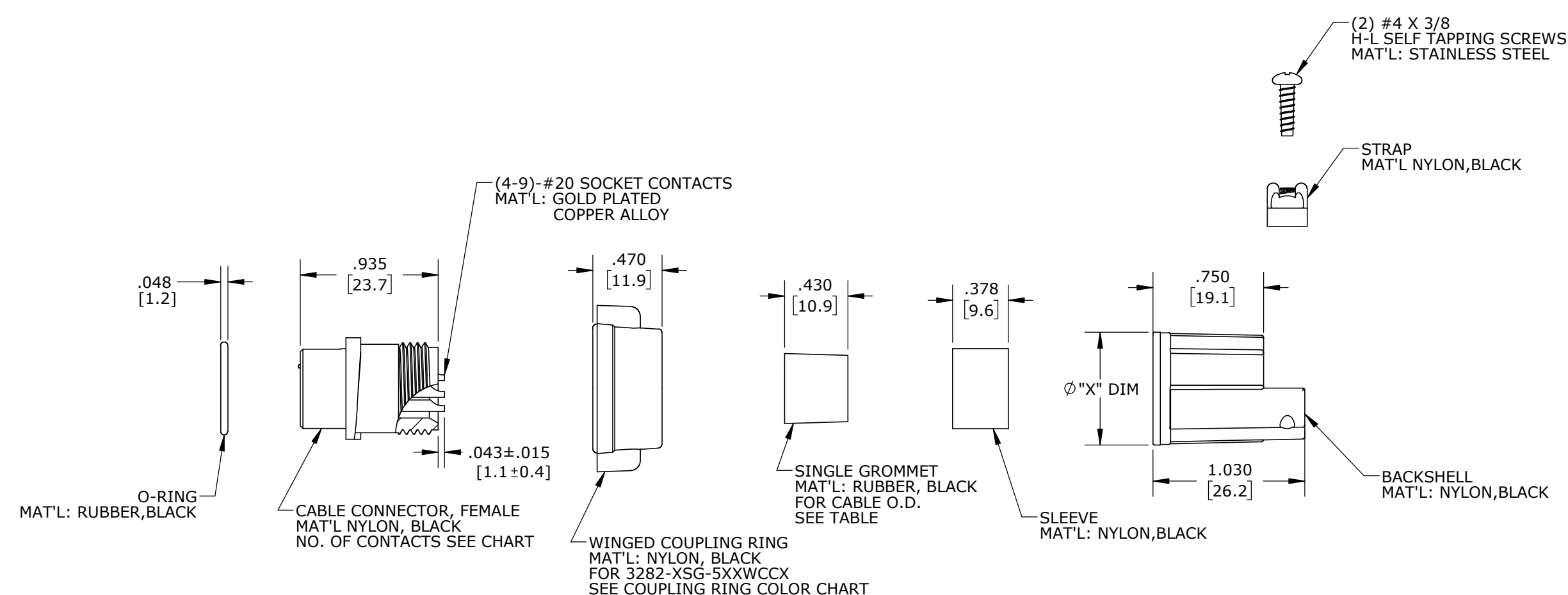

ASSEMBLED VIEW
FOR CUSTOMER REFERENCE

DIMENSIONS IN BRACKETS [] ARE METRIC

CUSTOMER APPROVAL

THIS DOCUMENT CONTAINS CONFIDENTIAL INFORMATION PROPRIETARY TO CONXALL CORPORATION. ANY REPRODUCTION, DISCLOSURE, OR USE OF THIS DOCUMENT /INFORMATION IS EXPRESSLY PROHIBITED UNLESS AUTHORIZED IN WRITING BY CONXALL CORPORATION.

APPROVED BY: _____

DATE: _____

RoHS COMPLIANT

A	AN	03-17-21	DRAWING CREATED DOR 15-E253SL #39
REV.	INIT.	DATE	DESCRIPTION
	AN	02-24-21	ORIG. DRAWN BY: DATE: 02-24-21
ALL INFORMATION ILLUSTRATED IS THE PROPERTY OF "CONXALL CORPORATION". UNAUTHORIZED DUPLICATION OR DISTRIBUTION OF THIS DOCUMENT IS PROHIBITED.			<p>601 E. WILDWOOD VILLA PARK, IL 60181</p>
ALL UNITS ARE IN FEET, INCHES, FRACTION OF INCHES AND DECIMALS.			
APPROVED BY:		TITLE: CONNECTOR ASS'Y KIT (4-9) #20 SOCKET CONTACTS (SOLDER) MULTI-CON-X, W/WINGED COUPLING NUT	
SCALE	SIZE	SHEET	CUSTOMER: STANDARD PRODUCT
NTS	B	1 OF 1	
FILE:	DIRECTORY:	PART NUMBER:	REV
3282-XSG-5XXW(CCX)	SLW	3282-XSG-5XXW(CCX)	A